

# Year 10 WJEC Knowledge Organisers

## Double Award Physics

### Topic list:

- 1.1 - Electric Circuits
- 1.2 - Generating Electricity
- 1.3 - Making Use of Energy
- 1.4 - Domestic Electricity
- 1.5 - Waves

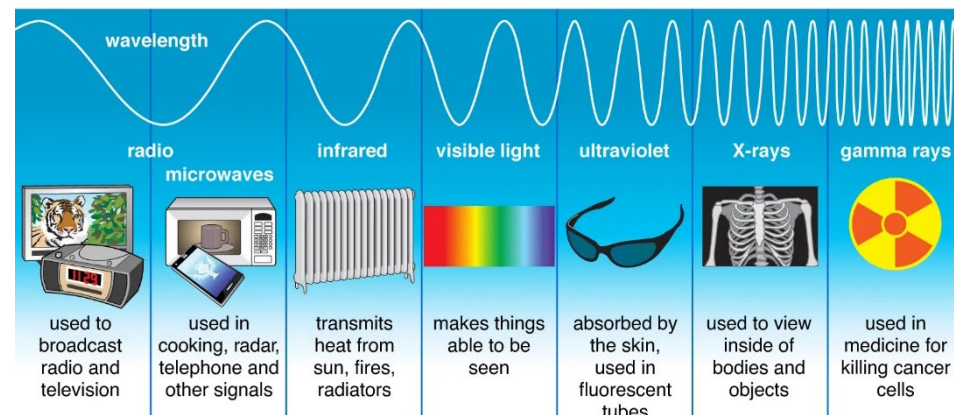

The following symbols are used to represent different electrical components:

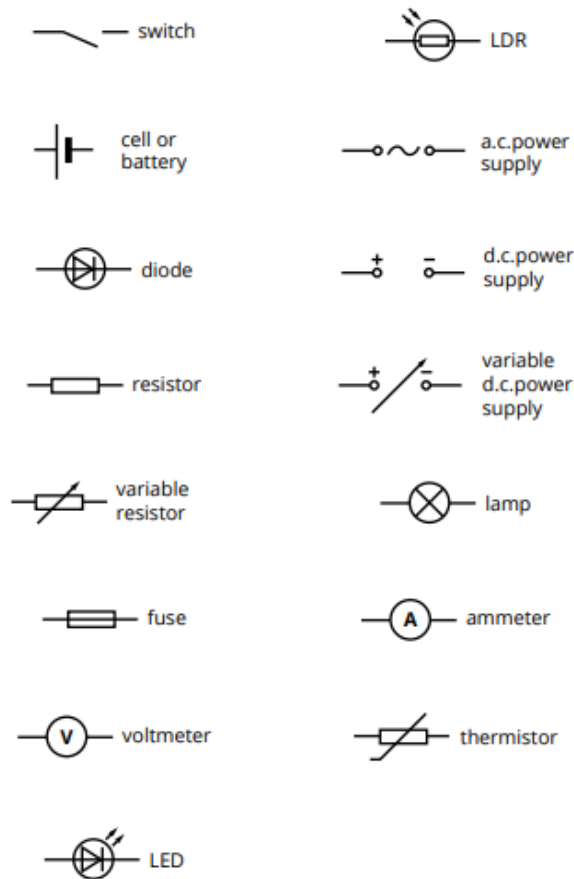

**Resistors** are used to control or change the current. Fixed resistors are used to lower the current but variable resistors, thermistors and LDRs (light dependent resistors) can change their resistance and change the current.  
**Variable resistors** can be changed by moving a slider or turning a dial, e.g. dimmer switch.  
**Thermistors** change depending on the **temperature**; higher temperature = lower resistance.  
**LDRs** change depending on the **light** on the LDR; brighter light = lower resistance.

When you draw a circuit, remember to draw the **correct symbols** in place first then connect using **straight** lines to represent the **wires**.

**Series and parallel circuits**

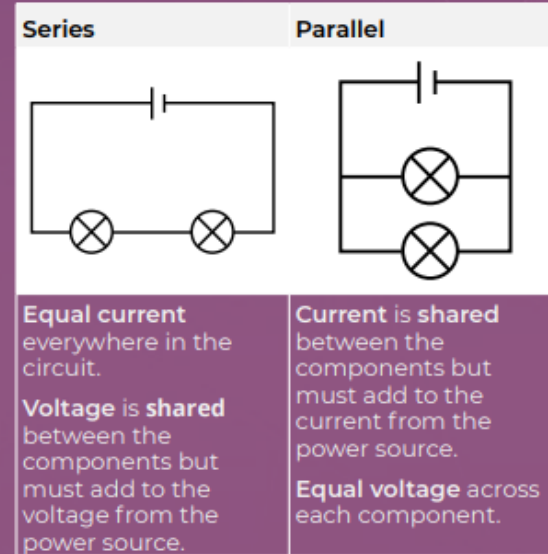

**Current** is measured using an **ammeter** which must be connected in **series**.  
**Voltage** is measured using a **voltmeter** which must be connected in **parallel**.

**Resistance** can be calculated using this equation:

$$\text{Current (A)} = \frac{\text{Voltage (V)}}{\text{Resistance (\Omega)}}$$

<b>Series</b> When you add resistors in series, the resistance increases according to this equation. $R = R_1 + R_2$	<b>Parallel</b> When you add resistors in parallel, the resistance of the circuit decreases. $\frac{1}{R} = \frac{1}{R_1} + \frac{1}{R_2}$
--	--

The **power** of a circuit represents the energy transferred per second. It is measured in Watts where **1W = 1 Joule per second**. These equations can be used to calculate power:

$$\text{Power(W)} = \text{Voltage(V)} \times \text{Current(A)}$$

$$\text{Power(W)} = \text{Current(A)}^2 \times \text{Resistance(\Omega)}$$

$$\text{Energy(J)} = \text{Power(W)} \times \text{Time(s)}$$

This circuit can be used to **investigate how the current changes with voltage** for a bulb. The bulb can be swapped for a resistor or a diode to investigate the relationship with different components.

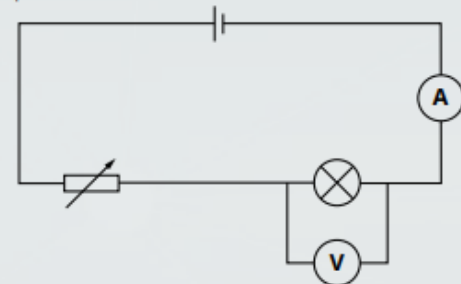

To get a **series** of values you must record the current and voltage then **adjust the variable resistor** and take the next set of results. You can **repeat** this until you have a complete set.

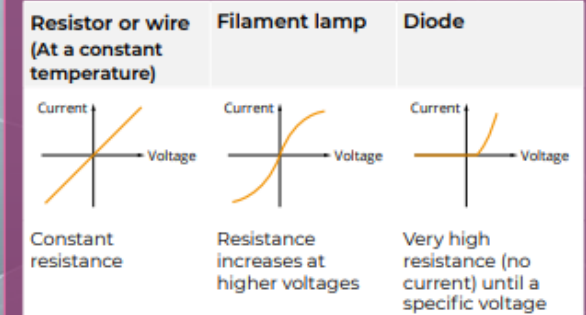

These are the results you would get from each device. You must learn the shape of the curve and be able to describe why it is that shape.



**Renewable energy:**

A source of energy which is not going to run out. For example: Wind, Solar, Geothermal, Hydroelectric and Biomass.

**Non-renewable energy:**

A source of energy which is going to run out. For example: Coal, Oil, Natural Gas and Nuclear.

Source	Advantages	Disadvantages
Wind, Solar	Renewable No waste or pollution	Low power output Unreliable – dependant on the weather Considered unsightly
Coal, Oil, Gas	Reliable Large power output	Non-renewable Produce greenhouse gasses Cause acid rain (mainly with coal)
Nuclear	Reliable Large power output No greenhouse gasses	Non-renewable Long start up time Produces radioactive waste which must be stored for a long time Expensive to commission and decommission
Hydroelectric	Renewable Reliable Short start up time No waste or pollution	Not many suitable places for this power station Must flood a large area which affects wildlife
Tidal power	Renewable No waste or pollution	Must flood a large area which affects wildlife
Biomass	Renewable Reliable Carbon neutral	Uses a lot of crops which require a lot of land to grow

**Efficiency**

Efficiency can be calculated using this equation:

$$\% \text{ efficiency} = \frac{\text{energy usefully transferred}}{\text{total energy supplied}} \times 100\%$$

You do not need to remember the equation, it will be on the equation sheet, but it is important to choose the correct values for the equation. Useful energy is the energy you want to use from the power station and the energy supplied is the energy put into the power station.

**Thermal power station (for example Coal, Biomass, Nuclear, Geothermal)**

Heat is created in the **furnace** by burning a fuel, or a nuclear reaction in nuclear power.

This heat turns water to steam which moves through the pipes to the **turbine**.

This turns the turbine which in turn turns the **generator**.

This generates **electricity** which is supplied to the **National Grid**.

The steam is cooled and sent back to the furnace to be heated again.

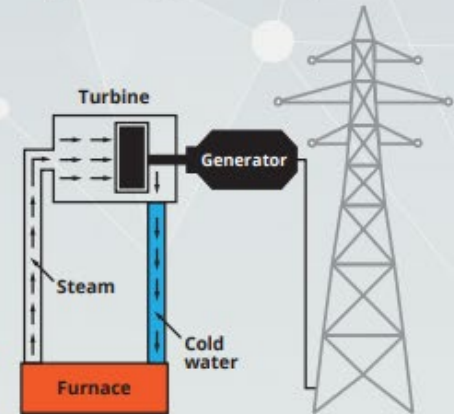

**National Grid**

The National Grid is a **network** of cables which connects every power station to every home, shop, factory, school, hospital and every other consumer.

Demand for power **changes** due to the seasons, weather and time of day. For example, at the end of a popular TV programme there is a sudden demand for electricity as people put their kettles on at the same time. **To meet this demand**, the National Grid switches on extra hydroelectric power stations or buys extra electricity from abroad.

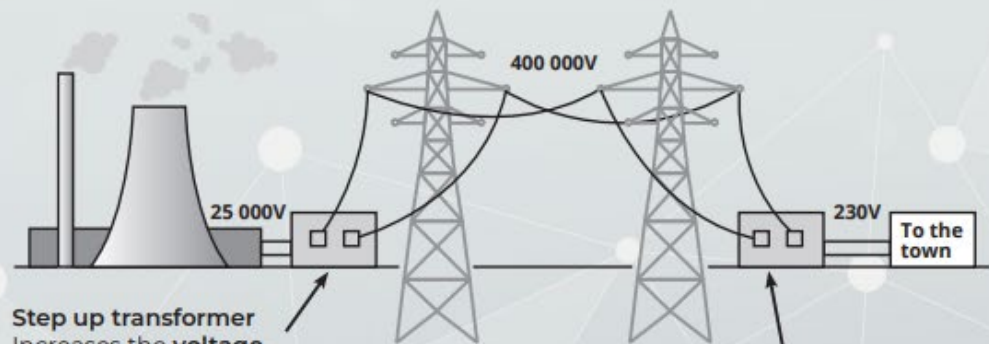

**Step up transformer**  
Increases the **voltage**, which reduces the **current** and lowers **heat losses** in the cables. This increases the grid's efficiency.

**Step down transformer**  
Lowers voltage to a **safer** level

To calculate density, you must use this equation:  $density = \frac{mass}{volume}$

You do not have to remember the equation but it is important to choose the correct values to use.

### Units

Density is measure in  $g/cm^3$  or in  $kg/m^3$ . Look for units in the question to know which of these options to use with your answer.

In order to use the equation, you must know the **mass** and the **volume**. The different methods to find these are described below. When you describe how to calculate density, remember to name the **equipment** you need and how to use it.

### Calculating the density of a regularly shaped solid

1. Measure the mass using a balance.  
*e.g. 25g*
2. Use a ruler to measure the length, width and height of the solid.  
*e.g. 3.0cm, 2.0cm, 1.5cm*
3. Calculate the volume using:  
volume = length  $\times$  width  $\times$  height  
*e.g.  $3.0 \times 2.0 \times 1.5 = 9.0cm^3$*
4. Calculate the density using  
density =  $\frac{mass}{volume}$   
*e.g. density =  $\frac{25}{9} = 2.8 g/cm^3$*

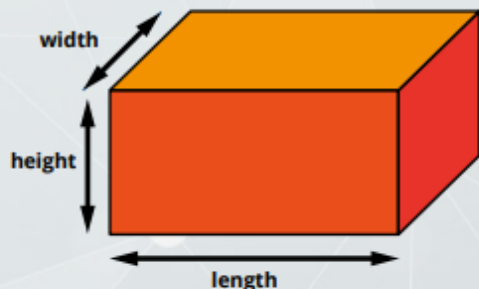

### Calculating the density of an irregularly shaped solid

1. Measure the mass using a balance.  
*e.g. 6.0g*
2. Fill a measuring cylinder with water to a specific volume.  
*e.g. 28cm<sup>3</sup>*
3. Place the solid in the measuring cylinder and record the new volume.  
*e.g. 33cm<sup>3</sup>*
4. Calculate the volume of the solid by subtracting the initial volume (step 2) from the new volume (step 3).  
*e.g.  $33 - 28 = 5cm^3$*
5. Calculate the density using:  
density =  $\frac{mass}{volume}$   
*e.g. density =  $\frac{6.0}{5} = 1.2 g/cm^3$*

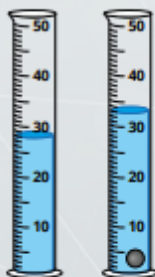

### Variations

What if the solid floats in the water? Then you must use something to ensure the solid is completely under the water. Remember if you use something to sink the solid you must subtract its volume and the volume of the water from the new volume.

### Calculating the density of a liquid

1. Measure the mass of an empty measuring cylinder.  
*e.g. 80.0g*
2. Fill the measuring cylinder with a specific volume of the liquid. Record the volume.  
*e.g. 20cm<sup>3</sup>*
3. Measure the combined mass of the measuring cylinder and the liquid.  
*e.g. 96.0g*
4. Calculate the mass of the liquid by subtracting the empty mass (step 2) from the new mass (step 3).  
*e.g.  $96.0 - 80.0 = 16.0g$*
5. Calculate the density using:  
density =  $\frac{mass}{volume}$   
*e.g. density =  $\frac{16.0}{2.0} = 0.8 g/cm^3$*

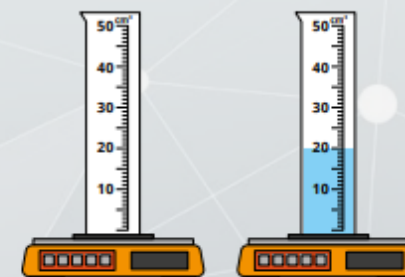



## Unit 1.3/3.3 Heat transfer

Heat always transfers **from hot to cold**, but how it transfers depends on the material or state of the matter (solid, liquid, gas or vacuum).

The greater the **difference** in temperature, the greater the **rate** of heat transfer.

A mug of tea at 90 °C will cool quicker outside where the temperature is 5 °C than in the house where the temperature is 20 °C.

### Conduction

Conduction happens in **solids**. Heat energy causes the **particles** to vibrate more and is transferred from one particle to the next as they **collide**. **Metals** are the best conductors as they have free **electrons** that can move the energy quickly from the hot side to the cold.

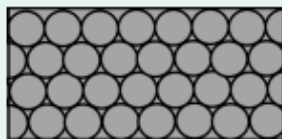

Air is a poor conductor as it is a gas. It has large gaps between particles and reduces the rate of collisions. This makes it very useful as an **insulator**.

### Convection

Convection happens in **liquids** and **gases**. Heat energy causes the **particles** to move quicker and make them move **further apart**. This means there will be fewer particles in a specific volume and therefore will be **less dense**. This less dense liquid or gas will **rise above** the denser cold liquid, this forms a **convection current**.

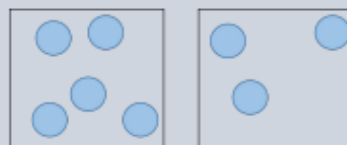

Cold gas

Hot gas

### Radiation

All warm things **emit** heat **radiation** in the form of infrared waves. Hotter bodies emit more radiation than cold bodies. These **waves** can travel through **solids, liquids, gases** and through a **vacuum** like space. They travel in **all directions** from the hot body into a colder body.

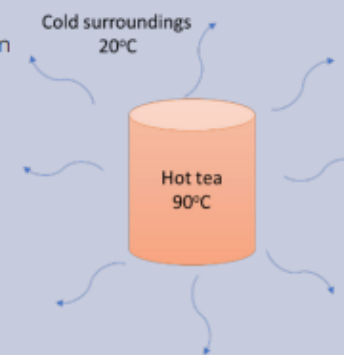

**Black** surfaces **absorb** radiation best and **emit** radiation best. Tea in a black mug will cool down quicker than tea in a white mug.

**Shiny** surfaces **reflect** radiation well but are poor emitters and absorbers.

Loft insulation reduces heat loss due to **conduction**. Fibreglass wool between the ceiling and the loft space has pockets of trapped air which acts as an insulator.

Double glazed windows reduce heat losses due to **conduction**. Trapping air between two layers of glass acts as an insulator.

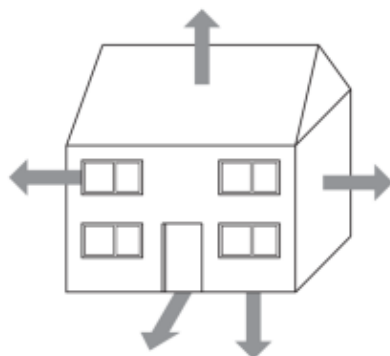

Cavity walls reduce heat losses due to **conduction**. Trapping air between two layers of bricks acts as an insulator. Filling the cavity (gap) with fibreglass wool or foam stops the air in the gap moving and reduces **convection**.

Stopping draughts reduces **convection** currents in the house through stopping cold air being sucked into the house as the hot air inside rises.

Floor insulation reduces heat losses due to **conduction**. Fibreglass wool below the floor has pockets of trapped air that acts as an insulator.

### Payback time

Comparing different methods of insulating the home is difficult as the **initial cost** and the **saving each year** for the methods can be very different. To compare methods, it is important to be able to calculate the payback time, which is the time it takes to save the same amount as the initial cost of insulation.

**For example, loft insulation that costs £400 but saves £50 each year will take 8 years to pay back, whereas loft insulation that costs £500 but saves £100 each year has a pay back time of 5 years.**

*The equation is not to be given on the equation page.*

$$\text{Payback time} = \frac{\text{installation cost}}{\text{annual savings}}$$

The amount of energy used in the home is measured in kilowatt hours (**kWh**), also known as **Units**, where 1 kWh is equal to the energy converted by a 1 kW device for 1 hour.

In order to calculate the cost, these equations are used:

$$\text{Units used (kWh)} = \text{Power (kW)} \times \text{time (hours)}$$

$$\text{Cost} = \text{Units used} \times \text{Cost per unit}$$

Both equations are given on the equation sheet, **but it is important that you can convert between units correctly**. Often power is given in Watts and time in seconds or minutes.



The **efficiency** of a device is shown on a scale like this - the more efficient a device, the better its rating will be.

This is important as it will help **compare** devices that do the same thing. For example, two televisions of the same size and picture quality but different energy ratings will have a different cost to use.

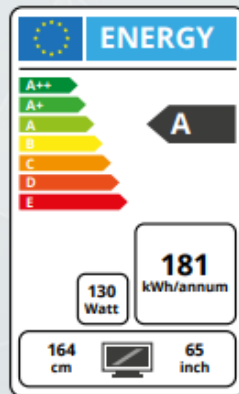

Electricity can be supplied in two ways; with an Alternating Current (AC) or a Direct Current (DC).

AC	DC
Voltage constantly changes size and the current constantly changes direction.	Voltage and current have a constant size and direction.
Supplied by the National Grid.	Supplied by batteries.

There are 3 wires in the ring main circuit:

1. **Live** – this carries a current into the house at a **high voltage**.
2. **Earth** – operating normally this wire carries no current.
3. **Neutral** – this completes the circuit and has the **same current** as the live wire but a lower voltage.

The earth wire is connected to the casing of any device with a **metal** case. This is so that *if the live wire touches the casing due to a fault*, then the current will travel **safely** to the earth through the earth wire rather than through a person who touches the casing.

The electrical circuits in your home are connected using a **ring main** circuit.

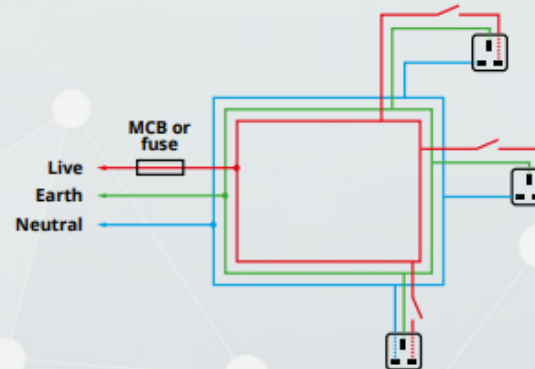

The advantages of a ring main circuit are:

- The current can travel two ways so you can make the wires thinner and have a lower current in each part.
- You can add more sockets anywhere on the ring and each will have the same voltage (230V).

There are three other safety devices used in these circuits:

<b>Fuse</b>	Stops the <b>current</b> if it becomes too <b>large</b> . It does this by melting a wire in the fuse. This means the fuse must be replaced once it has 'blown'.  This prevents the device overheating.
<b>Miniature circuit breaker (MCB)</b>	Stops the <b>current</b> if it becomes too <b>large</b> . Reacts more <b>quickly</b> and can be <b>reset</b> .  This prevents the device overheating.
<b>Residual current circuit breaker (RCCB)</b>	Stops the current if the current in the <b>neutral wire is different to the live wire</b> (remember, when the circuit is operating normally the current will be the same in both). Reacts to a <b>very small</b> difference, reacts very <b>quickly</b> and can be <b>reset</b> . This will protect the user from a serious electric shock.

There are two different types of waves, longitudinal and transverse.

**Transverse:**



Direction of travel

A transverse wave has **vibrations** at 90° to the direction of travel.

**Longitudinal:**

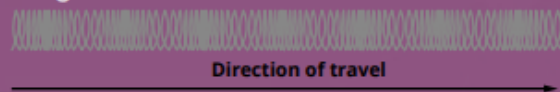

Direction of travel

A longitudinal wave has **vibrations** parallel to the direction of travel.



In this example there are **two** complete waves shown.

You must be able to describe a wave in terms of its wavelength, amplitude and frequency.

**Wavelength = the length of one complete wave**

**Amplitude = maximum displacement**

**Frequency = the number of waves in 1 second**

For the wave shown:

Wavelength = 4 units

Amplitude = 2 units

**Wave speed** can be calculated in two ways, both equations are given on the equation sheet so use the **units** to help decide which you need to use.

$$\text{Speed (m/s)} = \frac{\text{distance (m)}}{\text{time (s)}}$$

$$\text{Wave speed} = \text{wavelength(m)} \times \text{frequency(Hz)}$$

**Satellite communication**

There are two kinds of satellite used, both take 24 hours to orbit.

**Geosynchronous** returns to the same point **once** every 24 hours.

**Geostationary** stays **above** the same point at **all times**.

Using geostationary satellites to send messages requires at least 3 satellites. Remember the signal must travel up to the satellite and back and cannot travel straight from one satellite to another without returning to a station on the ground first.

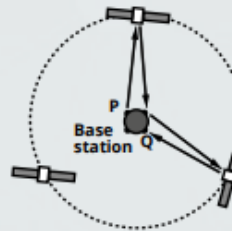

**Refraction**



Low optical density/  
deep water  
Higher speed  
Longer wavelength

High optical density/  
shallow water  
Slower  
Shorter wavelength

Notice the change in direction and the change in wavelength due to the change in speed.

Low optical density/  
deep water  
Higher speed  
Longer wavelength

**Reflection**

Notice that the wavelength does not change this time and that the angle from the normal to the wave when it hits the object is the same as when it is reflected.

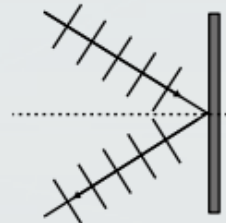

**The Electromagnetic spectrum**

All parts of the spectrum transfer energy, they are all transverse waves and all travel at the same speed in a vacuum ( $3 \times 10^8 \text{m/s}$ ), but have different properties and uses.

Wave	Radio waves	Microwaves	Infrared	Visible light	Ultraviolet	X rays	Gamma rays
Wavelength	Long	←—————→					Short
Frequency	Low	—————→					High
Energy	Low	—————→					High
Danger	Low danger	Heating water molecules in cells	Heat/burns	Damage retina	Ionising, causes cancer	Ionising, causes cancer	Ionising, causes cancer
Uses	Radio Television	Satellite television Mobile phones Cooking food	Optical fibres Remote controls Heat treatment	The only part that can be seen with the naked eye	Fraud detection	Looking at broken bones	Kills cancer cells